

VOLTAGE REGULATOR WITH ON/OFF SWITCH

FEATURES

- High Voltage Precision at $\pm 2.0\%$ or ± 60 mV
- Active High On/Off Control
- Very Low Dropout Voltage (85 mV at 30 mA)
- Very Low Noise
- Miniature Package (SOT-23-5)
- Internal Thermal Shutdown
- Short Circuit Protection
- Excellent Ripple Rejection (70 dB @ 1 kHz)
- Reverse Bias Protection

DESCRIPTION

The TK111xxS is a low dropout linear regulator with a built-in electronic switch. The internal switch can be controlled by TTL or CMOS logic levels. The device is in the "on" state when the control pin is pulled to a logic high level. An external capacitor can be connected to the noise bypass pin to lower the output noise level to 30 μ Vrms.

An internal PNP pass transistor is used to achieve a low dropout voltage of 85 mV (typ.) at 30 mA load current. The TK111xxS has a very low quiescent current of 140 μ A (typ.) at no load. The standby current is 100 nA maximum. The internal thermal shut down circuitry limits the junction temperature to below 150 °C. The load current is internally monitored and the device will shut down in the presence of a short circuit or overcurrent condition at the output.

The TK111xxS is available in a miniature SOT-23-5 surface mount package.

APPLICATIONS

- Battery Powered Systems
- Cellular Telephones
- Pagers
- Personal Communications Equipment
- Portable Instrumentation
- Portable Consumer Equipment
- Radio Control Systems
- Toys

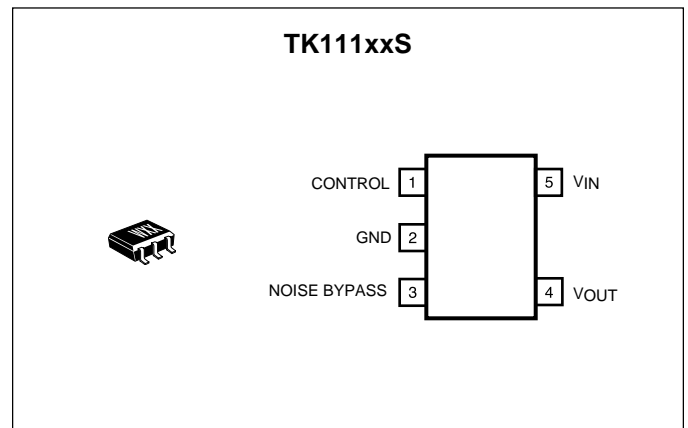

ORDERING INFORMATION

TK111□□S□L

Voltage Code

Tape/Reel Code

Temp. Code

Package Code

VOLTAGE CODE			Note 1: 2.0 to 2.3 V available in C temperature code (-30 to +80 °C) only	TAPE/REEL CODE
20 = 2.0 V	32 = 3.2 V	43 = 4.3 V		L: Tape Left
21 = 2.1 V	33 = 3.3 V	44 = 4.4 V		PACKAGE CODE
22 = 2.2 V	34 = 3.4 V	45 = 4.5 V		S: SOT-23-5
23 = 2.3 V	35 = 3.5 V	46 = 4.6 V		TEMP. CODE
24 = 2.4 V	36 = 3.6 V	47 = 4.7 V		C: -30 to +80 °C
25 = 2.5 V	37 = 3.7 V	48 = 4.8 V		I: -40 to +85 °C
27 = 2.7 V	38 = 3.8 V	49 = 4.9 V		
28 = 2.8 V	39 = 3.9 V	50 = 5.0 V		
29 = 2.9 V	40 = 4.0 V			
30 = 3.0 V	41 = 4.1 V			
31 = 3.1 V	42 = 4.2 V			

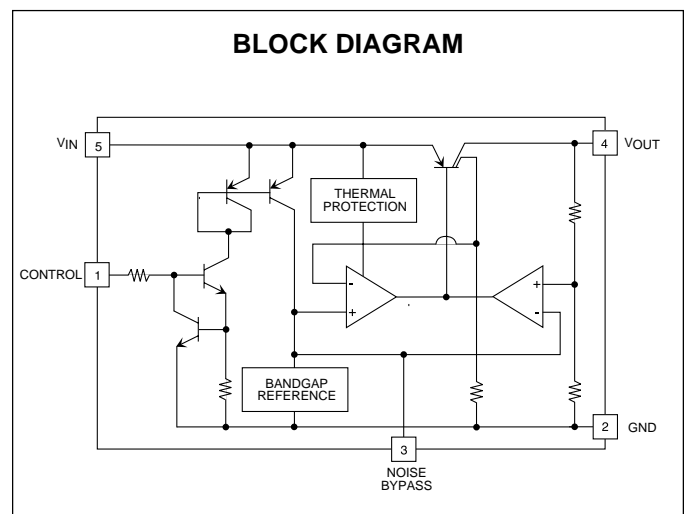

TK111xxS

ABSOLUTE MAXIMUM RATINGS TK111xxSCL

Supply Voltage	16 V	Storage Temperature Range	-55 to +150 °C
Control Terminal Voltage	12 V	Operating Temperature Range	-30 to +80 °C
Noise Bypass Terminal Voltage	5 V	Operating Voltage Range	1.8 to 12 V
Power Dissipation (Note 1)	500 mW	Junction Temperature	150 °C
Reverse Bias	10 V	Lead Soldering Temperature (10 s)	235 °C

TK111xxSCL ELECTRICAL CHARACTERISTICS

Test conditions: $V_{IN} = V_{OUT(TYP)} + 1 V$, $T_A = 25 °C$, unless otherwise specified.

SYMBOL	PARAMETER	TEST CONDITIONS	MIN	TYP	MAX	UNITS
I_Q	Quiescent Current	$I_{OUT} = 0$ mA, Excluding I_{CONT}		140	200	μA
I_{STBY}	Standby Current	$V_{IN} = 6$ V, Output OFF, $V_{CONT} \leq 0.15$ V			0.1	μA
V_{OUT}	Output Voltage	$I_{OUT} = 10$ mA, $V_{IN} = V_{OUT(TYP)} + 1$ V	See Table 1			V
Line Reg	Line Regulation	$V_{IN} = V_{OUT(TYP)} + 1$ V to $V_{OUT(TYP)} + 6$ V, (Note 2)		0.8	18	mV
Load Reg	Load Regulation	$I_{OUT} = 1$ to 60 mA, (Note 2)		8	30	mV
		$I_{OUT} = 1$ to 100 mA, (Note 2)		14	55	mV
V_{DROP}	Dropout Voltage	$I_{OUT} = 60$ mA, (Note 2)		120	200	mV
I_{OUT}	Continuous Output Current	(Note 2)			100	mA
$I_{OUT(PULSE)}$	Pulse Output Current	5 ms pulse, 12.5 % duty cycle, (Note 2)			130	mA
RR	Ripple Rejection	$f = 1$ kHz, $C_L = 4.7 \mu F$, $C_N = 0.1 \mu F$, $V_{IN} = V_{OUT(TYP)} + 2$ V, $V_R = 200$ mVrms, $I_{OUT} = 10$ mA, (Notes 3,4)		70		dB
V_{NO}	Output Noise Voltage	400 Hz $\leq f \leq$ 80 kHz, $C_L = 4.7 \mu F$, $C_N = 0.01 \mu F$, $V_{IN} = V_{OUT(TYP)} + 2$ V, $I_{OUT} = 10$ mA, (Notes 3,4)		30		$\mu Vrms$
V_{ref}	Noise Bypass Terminal Voltage			1.25		V
$\Delta V_{OUT} / \Delta T$	Temperature Coefficient	$I_{OUT} = 10$ mA		25		ppm/°C

CONTROL TERMINAL SPECIFICATIONS

I_{CONT}	Control Current	$V_{CONT} = 1.8$ V, Output ON		1.2	4	μA
$V_{CONT(ON)}$	Control Voltage ON	Output ON	1.5			V
$V_{CONT(OFF)}$	Control Voltage OFF	Output OFF			0.35	V

Note 1: Power dissipation is 500 mW when mounted as recommended. Derate at 4.0 mW/°C for operation above 25 °C.

Note 2: Refer to "Definition of Terms."

Note 3: Ripple rejection and noise voltage are affected by the value and characteristics of the capacitor used.

Note 4: Output noise voltage can be reduced by connecting a capacitor to the noise bypass terminal.

Gen. Note: Parameters with min. or max. values are 100% tested at $T_A = 25 °C$.

Gen. Note: Exceeding the "Absolute Maximum Ratings" can damage the device.

ABSOLUTE MAXIMUM RATINGS TK111xxSIL ($V_{OUT} \geq 2.4$ V)

Supply Voltage	15 V	Storage Temperature Range	-55 to +150 °C
Control Terminal Voltage	12 V	Operating Temperature Range	-40 to +85 °C
Noise Bypass Terminal Voltage	5 V	Operating Voltage Range	2.0 to 12 V
Power Dissipation (Note 1)	500 mW	Junction Temperature	150 °C
Reverse Bias	10 V	Lead Soldering Temperature (10 s)	235 °C

TK111xxSIL ELECTRICAL CHARACTERISTICS ($V_{OUT} \geq 2.4$ V)

Test conditions: $V_{IN} = V_{OUT(TYP)} + 1$ V, $T_A = -40$ to +85 °C, unless otherwise specified.

SYMBOL	PARAMETER	TEST CONDITIONS	MIN	TYP	MAX	UNITS
I_Q	Quiescent Current	$I_{OUT} = 0$ mA, Excluding I_{CONT}		140	200	μ A
I_{STBY}	Standby Current	$V_{IN} = 6$ V, Output OFF, $V_{CONT} \leq 0.15$ V			0.2	μ A
V_{OUT}	Output Voltage	$I_{OUT} = 10$ mA, $V_{IN} = V_{OUT(TYP)} + 1$ V	See Table 2			V
Line Reg	Line Regulation	$V_{IN} = V_{OUT(TYP)} + 1$ V to $V_{OUT(TYP)} + 6$ V, (Note 2)		0.8	18	mV
Load Reg	Load Regulation	$I_{OUT} = 1$ to 60 mA, (Note 2)		8	30	mV
		$I_{OUT} = 1$ to 100 mA, (Note 2)		14	55	mV
V_{DROP}	Dropout Voltage	$I_{OUT} = 60$ mA, (Note 2)		120	200	mV
I_{OUT}	Continuous Output Current	(Note 2)			100	mA
$I_{OUT(PULSE)}$	Pulse Output Current	5 ms pulse, 12.5 % duty cycle, (Note 2)			130	mA
RR	Ripple Rejection	$f = 1$ kHz, $C_L = 4.7$ μ F, $C_N = 0.1$ μ F, $V_{IN} = V_{OUT(TYP)} + 2$ V, $V_R = 200$ mVrms, $I_{OUT} = 10$ mA, (Notes 3,4)		70		dB
V_{NO}	Output Noise Voltage	400 Hz $\leq f \leq 80$ kHz, $C_L = 4.7$ μ F, $C_N = 0.01$ μ F, $V_{IN} = V_{OUT(TYP)} + 2$ V, $I_{OUT} = 10$ mA, (Notes 3,4)		30		μ Vrms
V_{ref}	Noise Bypass Terminal Voltage			1.25		V
$\Delta V_{OUT} / \Delta T$	Temperature Coefficient	$I_{OUT} = 10$ mA		25		ppm/°C

CONTROL TERMINAL SPECIFICATIONS

I_{CONT}	Control Current	$V_{CONT} = 1.8$ V, Output ON		1.2	6	μ A
$V_{CONT(ON)}$	Control Voltage ON	Output ON	1.5			V
$V_{CONT(OFF)}$	Control Voltage OFF	Output OFF			0.35	V

Note 1: Power dissipation is 500 mW when mounted as recommended. Derate at 4.0 mW/°C for operation above 25 °C.

Note 2: Refer to "Definition of Terms."

Note 3: Ripple rejection and noise voltage are affected by the value and characteristics of the capacitor used.

Note 4: Output noise voltage can be reduced by connecting a capacitor to the noise bypass terminal.

Gen. Note: Parameters with min. or max. values are 100% tested at $T_A = 25$ °C.

Gen. Note: Exceeding the "Absolute Maximum Ratings" can damage the device.

TK111xxSCL ELECTRICAL CHARACTERISTICS TABLE 1

Output Voltage	Voltage Code	V _{OUT(MIN)}	V _{OUT(MAX)}	Test Voltage
2.0 V	20	1.940 V	2.060 V	3.0 V
2.1 V	21	2.040 V	2.160 V	3.1 V
2.2 V	22	2.140 V	2.260 V	3.2 V
2.3 V	23	2.240 V	2.360 V	3.3 V
2.4 V	24	2.340 V	2.460 V	3.4 V
2.5 V	25	2.440 V	2.560 V	3.5 V
2.7 V	27	2.640 V	2.760 V	3.7 V
2.8 V	28	2.740 V	2.860 V	3.8 V
2.9 V	29	2.840 V	2.960 V	3.9 V
3.0 V	30	2.940 V	3.060 V	4.0 V
3.1 V	31	3.038 V	3.162 V	4.1 V
3.2 V	32	3.136 V	3.264 V	4.2 V
3.3 V	33	3.234 V	3.366 V	4.3 V
3.4 V	34	3.232 V	3.468 V	4.4 V
3.5 V	35	3.430 V	3.570 V	4.5 V

Output Voltage	Voltage Code	V _{OUT(MIN)}	V _{OUT(MAX)}	Test Voltage
3.6 V	36	3.528 V	3.672 V	4.6 V
3.7 V	37	3.626 V	3.774 V	4.7 V
3.8 V	38	3.724 V	3.876 V	4.8 V
3.9 V	39	3.822 V	3.978 V	4.9 V
4.0 V	40	3.920 V	4.080 V	5.0 V
4.1 V	41	4.018 V	4.182 V	5.1 V
4.2 V	42	4.116 V	4.284 V	5.2 V
4.3 V	43	4.214 V	4.386 V	5.3 V
4.4 V	44	4.312 V	4.488 V	5.4 V
4.5 V	45	4.410 V	4.590 V	5.5 V
4.6 V	46	4.508 V	4.692 V	5.6 V
4.7 V	47	4.606 V	4.794 V	5.7 V
4.8 V	48	4.704 V	4.896 V	5.8 V
4.9 V	49	4.802 V	4.988 V	5.9 V
5.0 V	50	4.900 V	5.100 V	6.0 V

TK111xxSIL ELECTRICAL CHARACTERISTICS TABLE 2Test Conditions: $V_{IN} = V_{OUT(TYP)} + 1\text{ V}$, $I_{OUT} = 30\text{ mA}$, unless otherwise specified.

Output Voltage	Voltage Code	Room Temp. Range ($T_A = 25\text{ }^\circ\text{C}$)		Full Temp. Range ($T_A = -40\text{ to }+85\text{ }^\circ\text{C}$)	
		$V_{OUT(MIN)}$	$V_{OUT(MAX)}$	$V_{OUT(MIN)}$	$V_{OUT(MAX)}$
2.4 V	24	2.340 V	2.460 V	2.305 V	2.495 V
2.5 V	25	2.440 V	2.560 V	2.405 V	2.595 V
2.7 V	27	2.640 V	2.760 V	2.605 V	2.795 V
2.8 V	28	2.740 V	2.860 V	2.705 V	2.895 V
2.9 V	29	2.840 V	2.960 V	2.805 V	2.995 V
3.0 V	30	2.940 V	3.060 V	2.905 V	3.095 V
3.1 V	31	3.038 V	3.162 V	3.007 V	3.193 V
3.2 V	32	3.136 V	3.264 V	3.104 V	3.296 V
3.3 V	33	3.234 V	3.366 V	3.201 V	3.400 V
3.4 V	34	3.332 V	3.468 V	3.298 V	3.502 V
3.5 V	35	3.430 V	3.570 V	3.395 V	3.605 V
3.6 V	36	3.528 V	3.672 V	3.492 V	3.708 V
3.7 V	37	3.626 V	3.774 V	3.589 V	3.811 V
3.8 V	38	3.724 V	3.876 V	3.686 V	3.914 V
3.9 V	39	3.822 V	3.988 V	3.783 V	4.017 V
4.0 V	40	3.920 V	4.080 V	3.880 V	4.120 V
4.1 V	41	4.018 V	4.182 V	3.977 V	4.223 V
4.2 V	42	4.116 V	4.284 V	4.074 V	4.326 V
4.3 V	43	4.214 V	4.366 V	4.171 V	4.429 V
4.4 V	44	4.312 V	4.488 V	4.268 V	4.532 V
4.5 V	45	4.410 V	4.590 V	4.365 V	4.635 V
4.6 V	46	4.598 V	4.692 V	4.462 V	4.738 V
4.7 V	47	4.696 V	4.794 V	4.559 V	4.841 V
4.8 V	48	4.794 V	4.896 V	4.656 V	4.944 V
4.9 V	49	4.892 V	4.998 V	4.753 V	5.047 V
5.0 V	50	4.900 V	5.100 V	4.850 V	5.150 V

TEST CIRCUIT

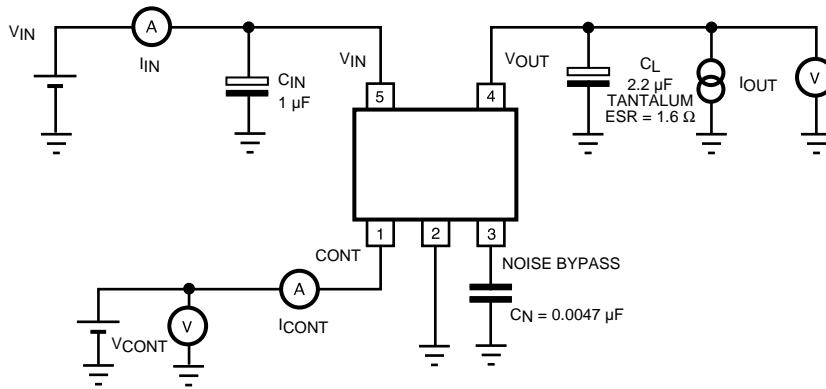

TYPICAL PERFORMANCE CHARACTERISTICS

$T_A = 25\text{ }^\circ\text{C}$, unless otherwise specified.

LOAD REGULATION

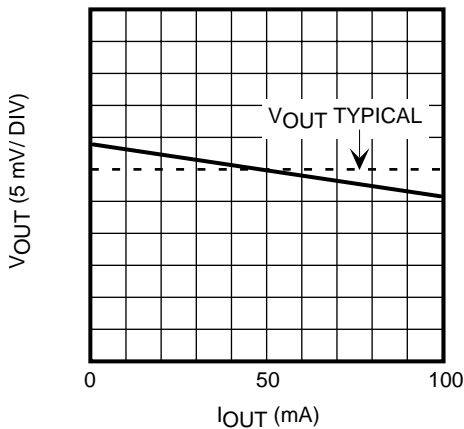

SHORT CIRCUIT CURRENT

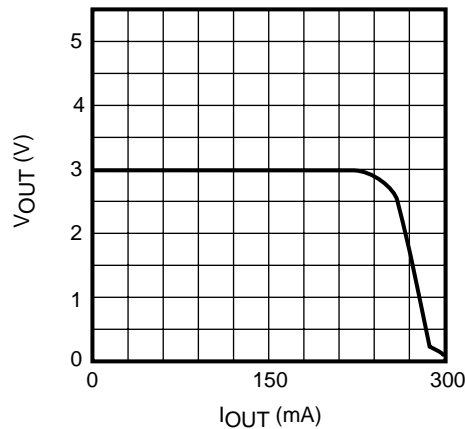

OUTPUT VOLTAGE vs. INPUT VOLTAGE

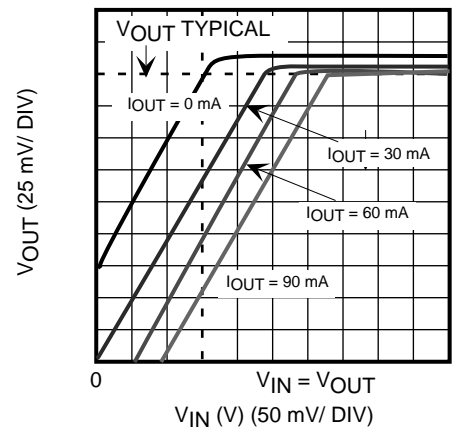

LINE REGULATION

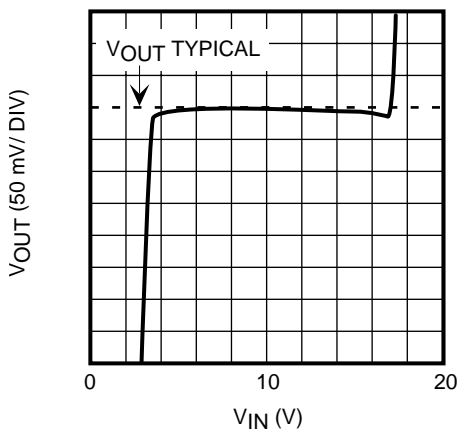

DROPOUT VOLTAGE vs. OUTPUT CURRENT

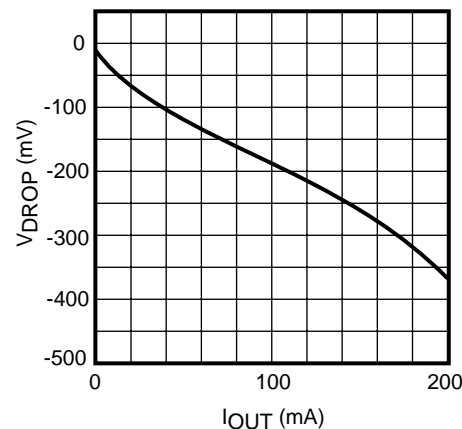

GROUND CURRENT vs. OUTPUT CURRENT

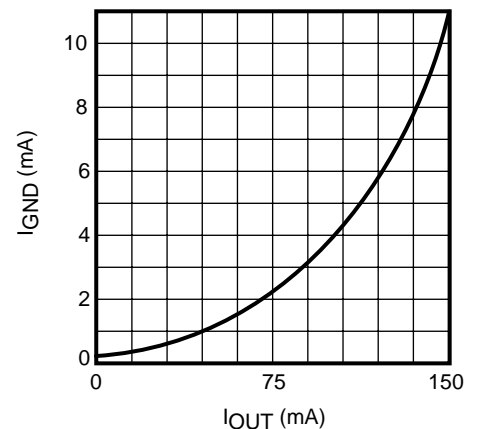

TYPICAL PERFORMANCE CHARACTERISTICS (CONT.)

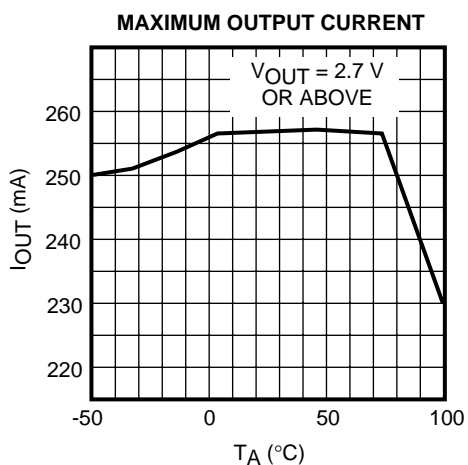
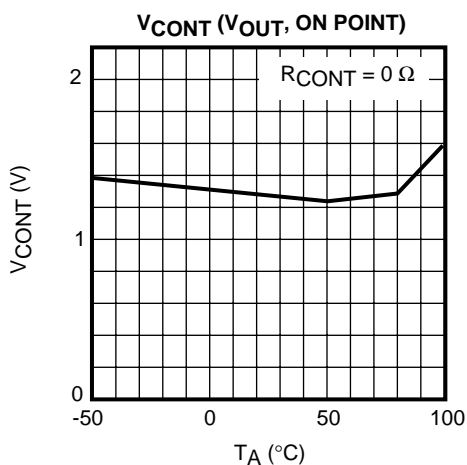
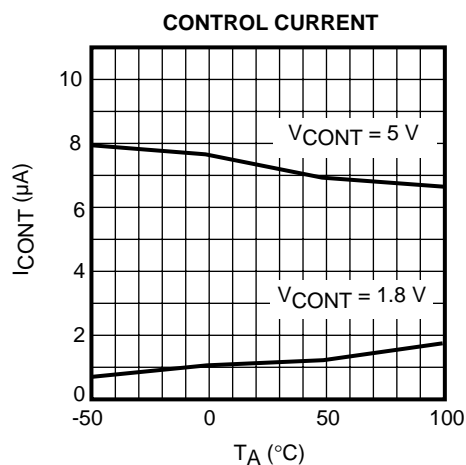
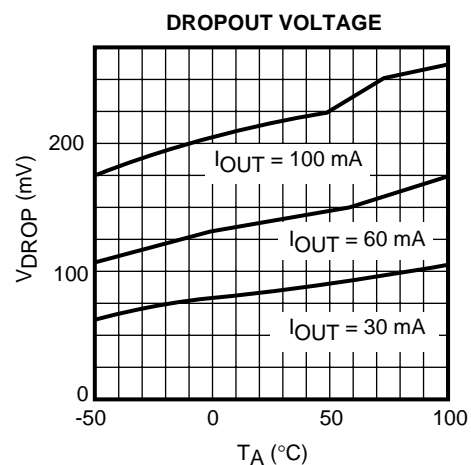
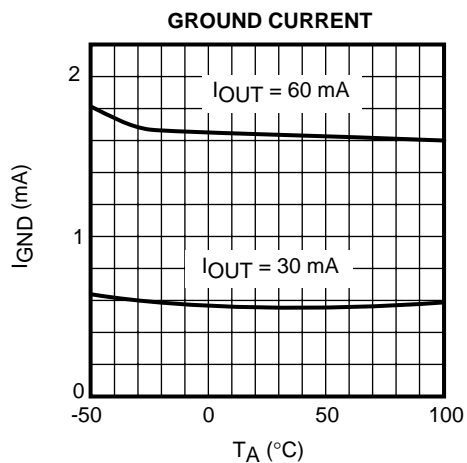
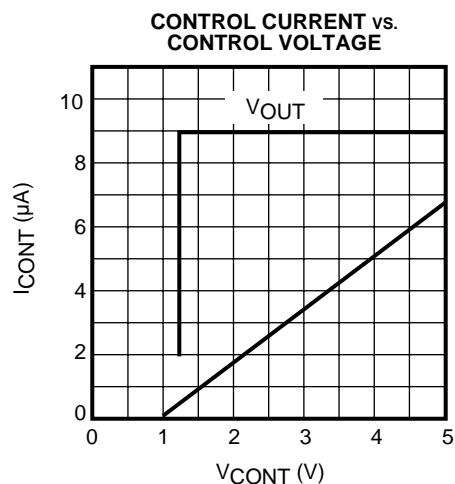
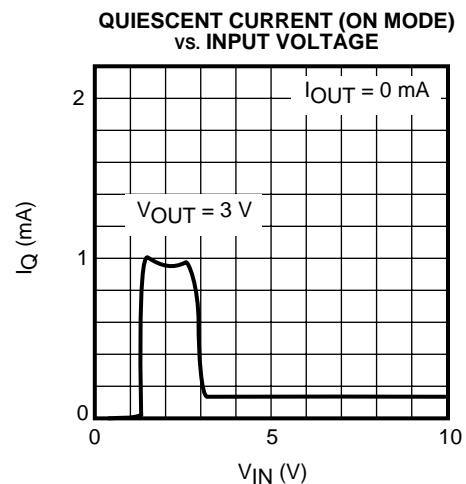
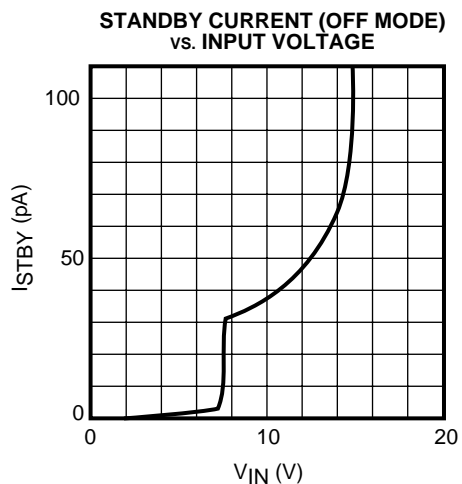
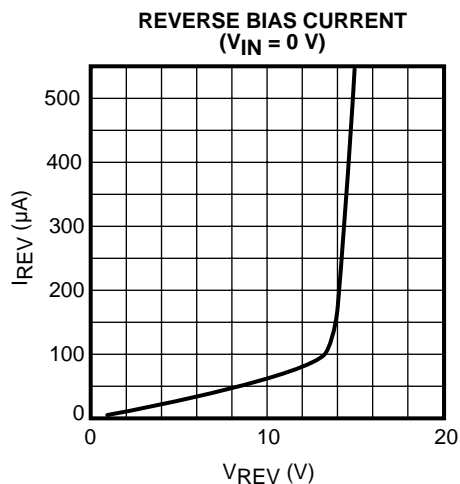
 $T_A = 25\text{ }^\circ\text{C}$, unless otherwise specified.

TYPICAL PERFORMANCE CHARACTERISTICS (CONT.)

$T_A = 25^\circ\text{C}$, unless otherwise specified.

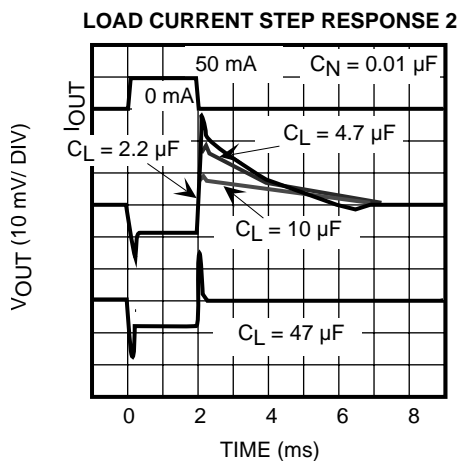
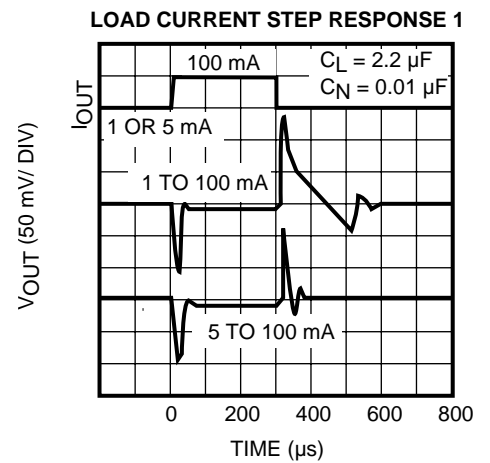
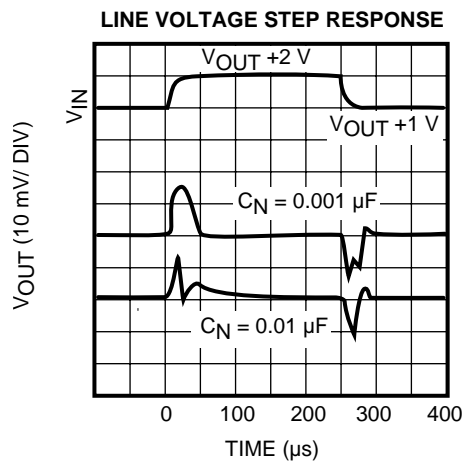
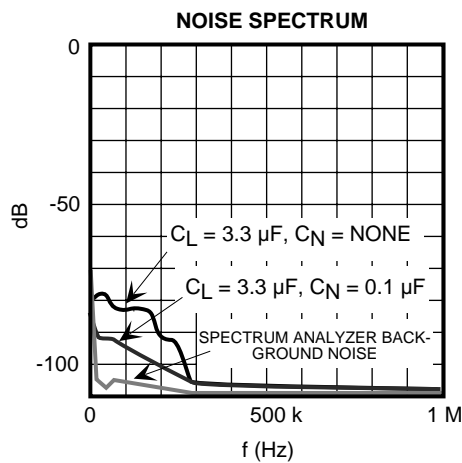
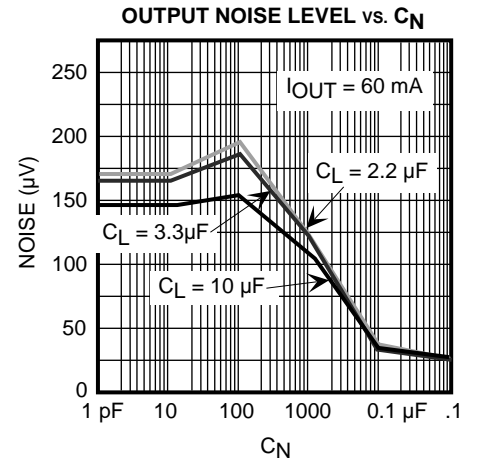
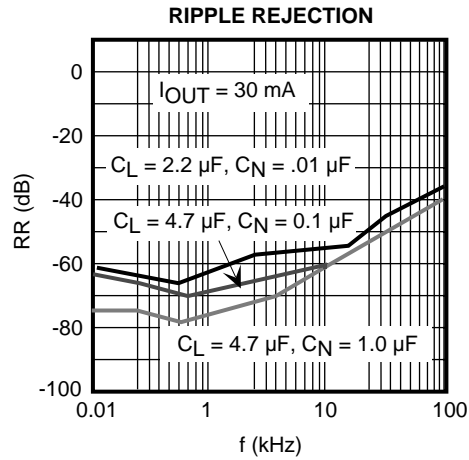
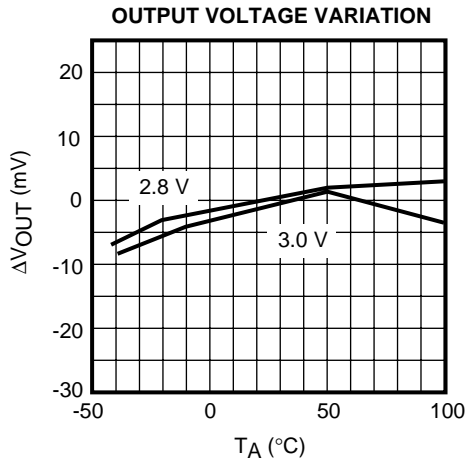

DEFINITION AND EXPLANATION OF TECHNICAL TERMS

OUTPUT VOLTAGE (V_{OUT})

The output voltage is specified with $V_{IN} = (V_{OUT(TYP)} + 1 \text{ V})$ and $I_{OUT} = 10 \text{ mA}$.

DROPOUT VOLTAGE (V_{DROPO})

The dropout voltage is the difference between the input voltage and the output voltage at which point the regulator starts to fall out of regulation. Below this value, the output voltage will fall as the input voltage is reduced. It is dependent upon the load current and the junction temperature.

OUTPUT CURRENT ($I_{OUT(MAX)}$)

The rated output current is specified under the condition where the output voltage drops 0.3 V below the value specified with $I_{OUT} = 10 \text{ mA}$. The input voltage is set to $V_{OUT} + 1 \text{ V}$, and the current is pulsed to minimize temperature effect.

CONTINUOUS OUTPUT CURRENT (I_{OUT})

Normal operating output current. This is limited by the package power dissipation.

PULSE OUTPUT CURRENT ($I_{OUT(PULSE)}$)

Max pulse width 5 ms, Duty cycle 12.5%: pulse load only.

LINE REGULATION (Line Reg)

Line regulation is the ability of the regulator to maintain a constant output voltage as the input voltage changes. The line regulation is specified as the input voltage is changed from $V_{IN} = V_{OUT(TYP)} + 1 \text{ V}$ to $V_{IN} = V_{OUT(TYP)} + 6 \text{ V}$.

LOAD REGULATION (Load Reg)

Load regulation is the ability of the regulator to maintain a constant output voltage as the load current changes. It is a pulsed measurement to minimize temperature effects with the input voltage set to $V_{IN} = V_{OUT(TYP)} + 1 \text{ V}$. The load regulation is specified under two output current step conditions of 1 mA to 60 mA and 1 mA to 100 mA.

QUIESCENT CURRENT (I_Q)

The quiescent current is the current which flows through

the ground terminal under no load conditions ($I_{OUT} = 0 \text{ mA}$).

GROUND CURRENT

Ground current is the current which flows through the ground pin(s). It is defined as $I_{IN} - I_{OUT}$, excluding control current.

RIPPLE REJECTION RATIO (RR)

Ripple rejection is the ability of the regulator to attenuate the ripple content of the input voltage at the output. It is specified with 200 mVrms, 1 kHz superimposed on the input voltage, where $V_{IN} = V_{OUT} + 2 \text{ V}$. The output decoupling capacitor is set to 4.7 μF , the noise bypass capacitor is set to 0.01 μF , 0.1 μF , 1.0 μF and the load current is set to 10 mA. Ripple rejection is the ratio of the ripple content of the output vs. the input and is expressed in dB.

Example: 64 dB at $C_N = 0.01 \mu\text{F}$, 70 dB at $C_N = 0.1 \mu\text{F}$, 74 dB at $C_N = 1.0 \mu\text{F}$.

STANDBY CURRENT (I_{STBY})

Standby current is the current which flows into the regulator when the output is turned off by the control function ($V_{CONT} = 0 \text{ V}$). It is measured with $V_{IN} = 6 \text{ V}$.

SENSOR CIRCUITS

Overcurrent Sensor

The overcurrent sensor protects the device in the event that the output is shorted to ground.

Thermal Sensor

The thermal sensor protects the device in the event that the junction temperature exceeds the safe value ($T_j = 150 \text{ }^\circ\text{C}$). This temperature rise can be caused by extreme heat, excessive power dissipation caused by large output voltage drops, or excessive output current. The regulator will shut off when the temperature exceeds the safe value. As the junction temperature decreases, the regulator will begin to operate again. Under sustained fault conditions, the regulator output will oscillate as the device turns off then resets. Damage may occur to the device under extreme fault conditions.

DEFINITION AND EXPLANATION OF TECHNICAL TERMS (CONT.)

Reverse Voltage Protection

Reverse voltage protection prevents damage due to the output voltage being higher than the input voltage. This fault condition can occur when the output capacitor remains charged and the input is reduced to zero, or when an external voltage higher than the input voltage is applied to the output side.

REDUCTION OF OUTPUT NOISE

Although the architecture of the Toko regulators is designed to minimize semiconductor noise, further reduction can be achieved by the selection of external components. The obvious solution is to increase the size of the output capacitor. A more effective solution would be to add a capacitor to the noise bypass terminal. The value of this capacitor should be 0.1 μF or higher (higher values provide greater noise reduction). Although stable operation is possible without the noise bypass capacitor, this terminal has a high impedance and care should be taken to avoid a large circuit area on the printed circuit board when the capacitor is not used. Please note that several parameters are affected by the value of the capacitors and bench testing is recommended when deviating from standard values.

CONTROL FUNCTION

The TK111xxS has an active high control pin. The control pin requires over 1.8 V for operation and under 0.6 V for standby. For the range of $0.6\text{ V} < V_{\text{CONT}} < 1.8\text{ V}$, operation is undefined. If the control function is not used, connect the control pin to V_{IN} .

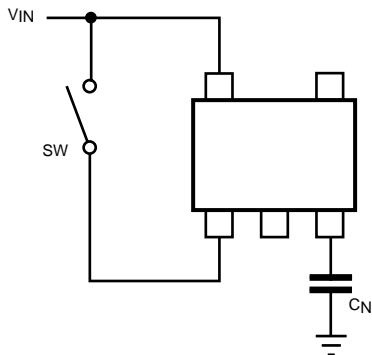

CONTROL FUNCTION

ON/OFF RESPONSE WITH CONTROL

The turn-on time depends upon the value of the output capacitor and the noise bypass capacitor. The turn-on time will increase with the value of either capacitor. The graphs below show the relationship between turn-on time and load capacitance. If the value of these capacitors is reduced, the load and line regulation will suffer and the noise voltage will increase. If the value of these capacitors is increased, the turn-on time will increase.

OUTPUT VOLTAGE RESPONSE B (OFF→ON)

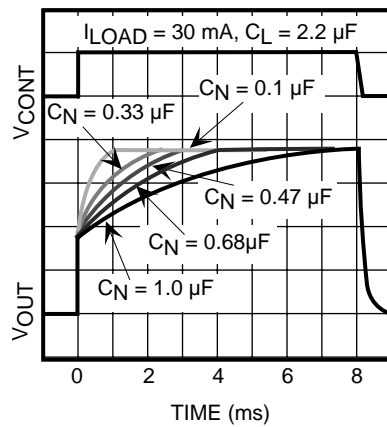

OUTPUT VOLTAGE RESPONSE A (OFF→ON)

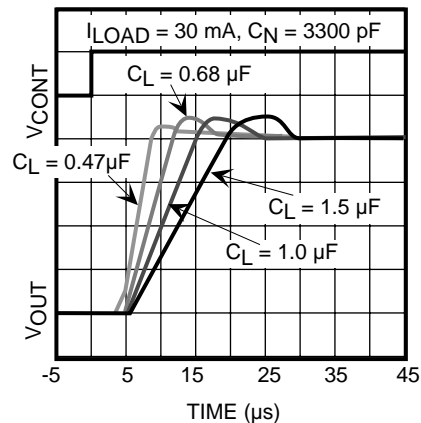

DEFINITION AND EXPLANATION OF TECHNICAL TERMS (CONT.)

PACKAGE POWER DISSIPATION (P_D)

This is the power dissipation level at which the thermal sensor is activated. The IC contains an internal thermal sensor which monitors the junction temperature. When the junction temperature exceeds the monitor threshold of 150 °C, the IC is shut down. The junction temperature rises as the difference between the input power ($V_{IN} \times I_{IN}$) and the output power ($V_{OUT} \times I_{OUT}$) increases. The rate of temperature rise is greatly affected by the mounting pad configuration on the PCB, the board material, and the ambient temperature. When the IC mounting has good thermal conductivity, the junction temperature will be low even if the power dissipation is great. When mounted on the recommended mounting pad, the power dissipation of the SOT-23-5 is increased to 500 mW. For operation at ambient temperatures over 25 °C, the power dissipation of the SOT-23-5 device should be derated at 4.0 mW/°C. To determine the power dissipation for shutdown when mounted, attach the device on the actual PCB and deliberately increase the output current (or raise the input voltage) until the thermal protection circuit is activated. Calculate the power dissipation of the device by subtracting the output power from the input power. These measurements should allow for the ambient temperature of the PCB. The value obtained from $P_D / (150\text{ °C} - T_A)$ is the derating factor. The PCB mounting pad should provide maximum thermal conductivity in order to maintain low device temperatures. As a general rule, the lower the temperature, the better the reliability of the device. The thermal resistance when mounted is expressed as follows:

$$T_j = \theta_{jA} \times P_D + T_A$$

For Toko ICs, the internal limit for junction temperature is 150 °C. If the ambient temperature (T_A) is 25 °C, then:

$$150\text{ °C} = \theta_{jA} \times P_D + 25\text{ °C}$$

$$\theta_{jA} = 125\text{ °C} / P_D$$

P_D is the value when the thermal sensor is activated. A simple way to determine P_D is to calculate $V_{IN} \times I_{IN}$ when the output side is shorted. Input current gradually falls as temperature rises. You should use the value when thermal equilibrium is reached.

The range of usable currents can also be found from the graph below.

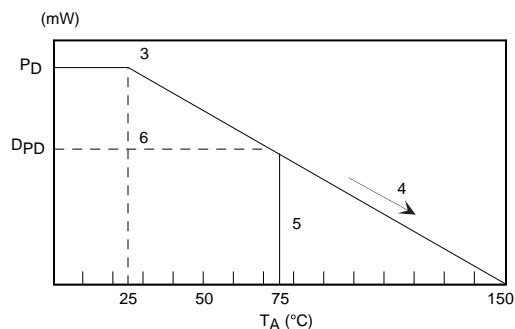

Procedure:

- 1) Find P_D
- 2) P_{D1} is taken to be $P_D \times (\sim 0.8 - 0.9)$
- 3) Plot P_{D1} against 25 °C
- 4) Connect P_{D1} to the point corresponding to the 150 °C with a straight line.
- 5) In design, take a vertical line from the maximum operating temperature (e.g., 75 °C) to the derating curve.
- 6) Read off the value of P_D against the point at which the vertical line intersects the derating curve. This is taken as the maximum power dissipation, D_{PD} .

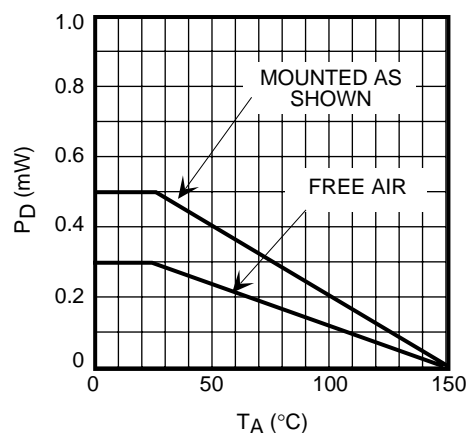

SOT-23-5 POWER DISSIPATION CURVE

APPLICATION INFORMATION

INPUT-OUTPUT CAPACITORS

Linear regulators require input and output capacitors in order to maintain regulator loop stability. The recommended minimum value of the input capacitor is 0.1 μF . The output capacitor should be selected within the Equivalent Series Resistance (ESR) range as shown in the graphs below for stable operation. When a ceramic capacitor is connected in parallel with the output capacitor, a maximum of 1000 pF is recommended. This is because the ceramic capacitor's electrical characteristics (capacitance and ESR) vary widely over temperature. If a large ceramic capacitor is used, a resistor should be connected in series with it to bring it into the stable operating area shown in the graphs below. Minimum resistance should be added to maintain load and line transient response.

Note: It is very important to check the selected manufacturers electrical characteristics (capacitance and ESR) over temperature.

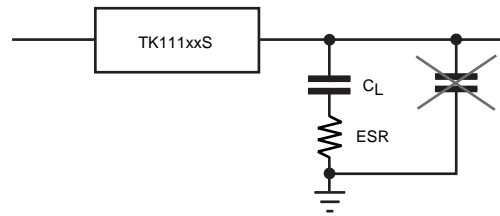
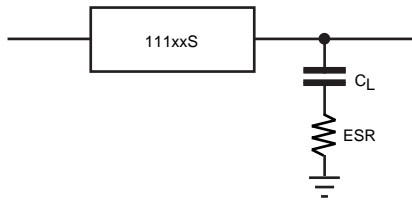

Note: It is not necessary to connect a ceramic capacitor in parallel with an aluminum or tantalum output capacitor.

$C_L = 1 \mu\text{F}$

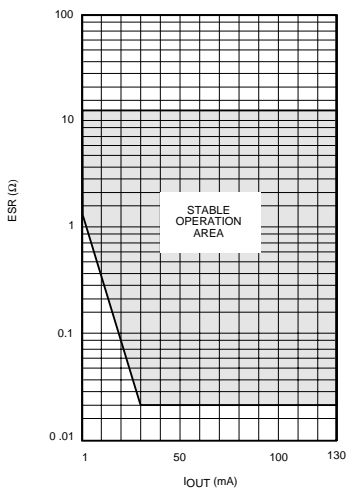

$C_L = 2.2 \mu\text{F}$

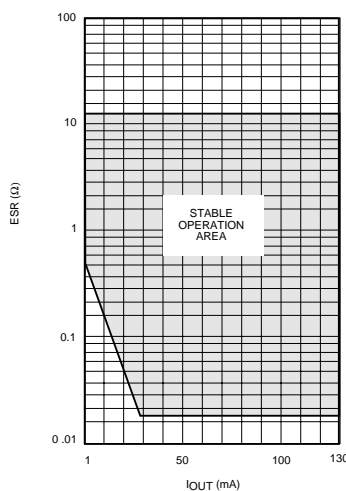

$C_L = 3.3 \mu\text{F}$

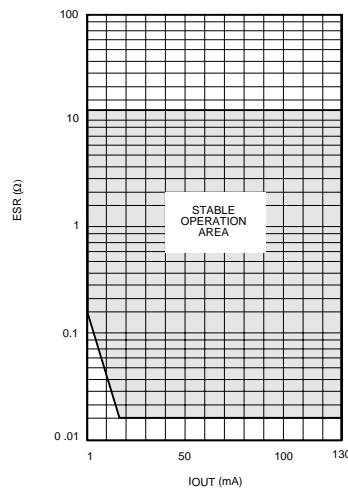

$C_L = 10 \mu\text{F}$

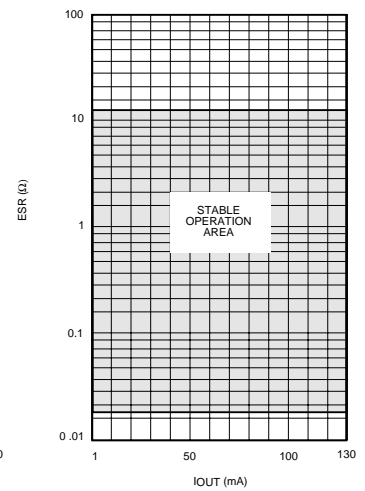

APPLICATION INFORMATION (CONT.)

The table below shows typical characteristics for several types and values of capacitance. Please note that the ESR varies widely depending upon manufacturer, type, size, and material.

ESR Capacitance	Aluminum Capacitor	Tantalum Capacitor	Ceramic Capacitor
1.0 μF	2.4 Ω	2.3 Ω	0.140 Ω
2.2 μF	2.0 Ω	1.9 Ω	0.059 Ω
3.3 μF	4.6 Ω	1.0 Ω	0.049 Ω
10 μF	1.4 Ω	0.5 Ω	0.025 Ω

Note: ESR is measured at 10 kHz.

BOARD LAYOUT

Copper pattern should be as large as possible. Power dissipation is 500 mW for the SOT-23-5. A low ESR capacitor is recommended. For low temperature operation, select a capacitor with a low ESR at the lowest operating temperature to prevent oscillation, degradation of ripple rejection and increase in noise. The minimum recommended capacitance is 1.0 μF .

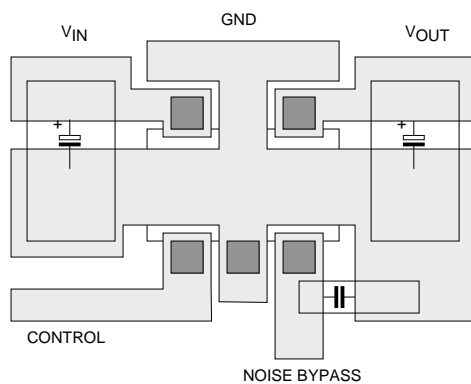

SOT-23-5 BOARD LAYOUT

NOTES

NOTES

PACKAGE OUTLINE

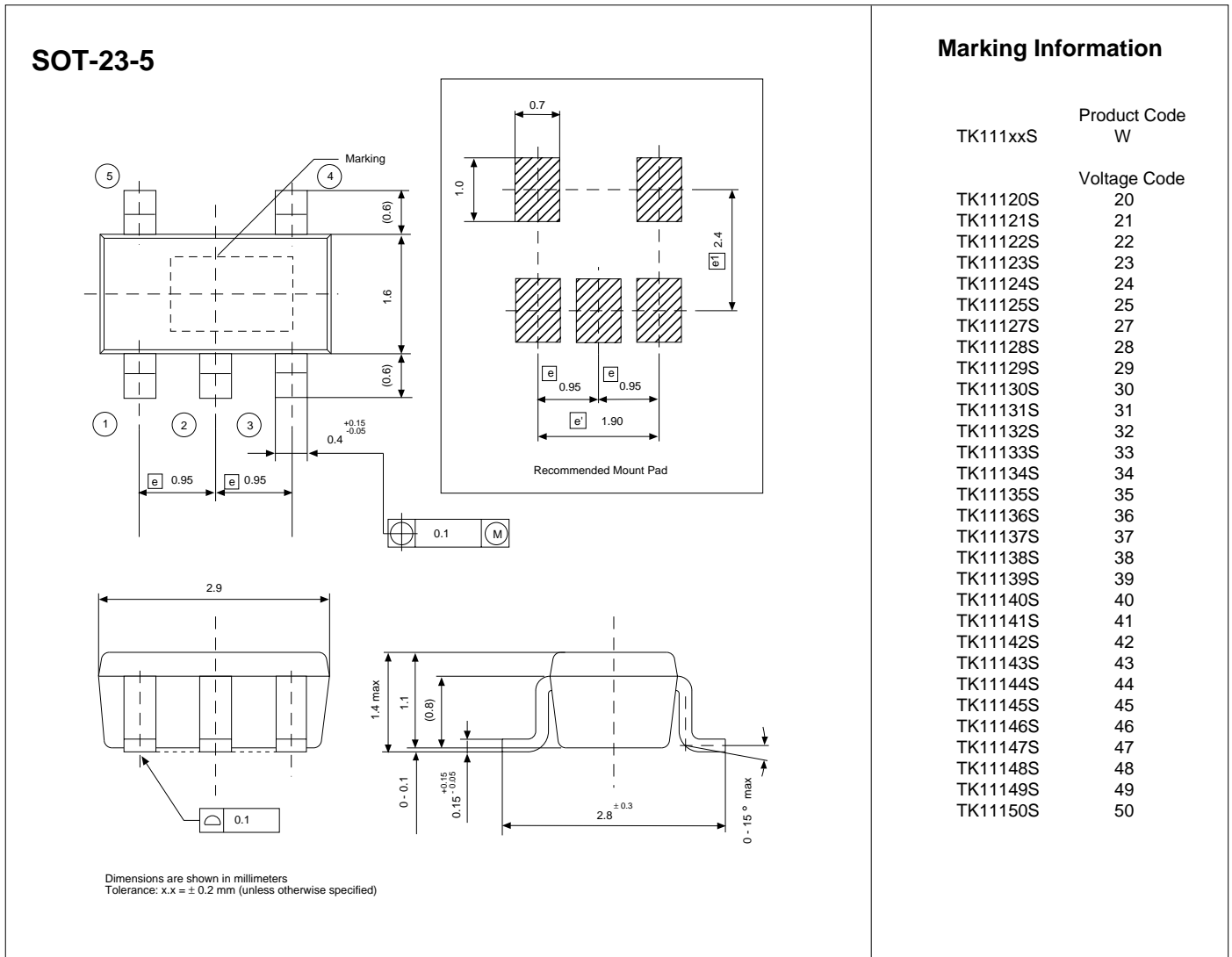

Toko America, Inc. Headquarters
1250 Feehanville Drive, Mount Prospect, Illinois 60056
Tel: (847) 297-0070 Fax: (847) 699-7864

TOKO AMERICA REGIONAL OFFICES

Midwest Regional Office
Toko America, Inc.
1250 Feehanville Drive
Mount Prospect, IL 60056
Tel: (847) 297-0070
Fax: (847) 699-7864

Western Regional Office
Toko America, Inc.
2480 North First Street, Suite 260
San Jose, CA 95131
Tel: (408) 432-8281
Fax: (408) 943-9790

Eastern Regional Office
Toko America, Inc.
107 Mill Plain Road
Danbury, CT 06811
Tel: (203) 748-6871
Fax: (203) 797-1223

Semiconductor Technical Support
Toko Design Center
4755 Forge Road
Colorado Springs, CO 80907
Tel: (719) 528-2200
Fax: (719) 528-2375

Visit our Internet site at <http://www.tokoam.com>

The information furnished by TOKO, Inc. is believed to be accurate and reliable. However, TOKO reserves the right to make changes or improvements in the design, specification or manufacture of its products without further notice. TOKO does not assume any liability arising from the application or use of any product or circuit described herein, nor for any infringements of patents or other rights of third parties which may result from the use of its products. No license is granted by implication or otherwise under any patent or patent rights of TOKO, Inc.